



## ■ Features

- Compliance to EN50155 and EN45545-2 railway standard
- Width only 32mm
- 2:1 wide input range
- -40~+70°C wide working temperature
- 150% peak load capability
- DC output adjustable
- Cooling by free air convection
- Can be installed on DIN rail TS-35/7.5 or 15
- Protections: Short circuit / Overload / Over voltage / Input reverse polarity / Input under voltage protection
- 4KVdc I/O isolation(Reinforced isolation)
- 3 years warranty

## ■ Applications

- Bus, tram, metro or railway system
- Industrial control system
- Semi-conductor fabrication equipment
- Factory automation
- Electro-mechanical
- Wireless network
- Telecom or datacom system

## ■ Description

DDR-120 series is a 120W DIN Rail type DC-DC converter with main features including DIN rail-type easy installation, ultra slim width (32mm), 2:1 wide input voltage, fanless design, -40~+70°C wide operating temperature, 4KVdc I/O isolation, 150% peak load, adjustable output voltage and full protective functions.

This series of models has various input options: 9~18V / 16.8~33.6V / 33.6~67.2V / 67.2~154V and various output options: 12V / 24V / 48V and can be used for industrial & railway control, security control, communication system and other fields. Suitable applications include DC buck/boost regulator, increasing system insulation level and voltage drop compensation along cable...etc.

## ■ Model Encoding

**DDR - 120 A - 24**

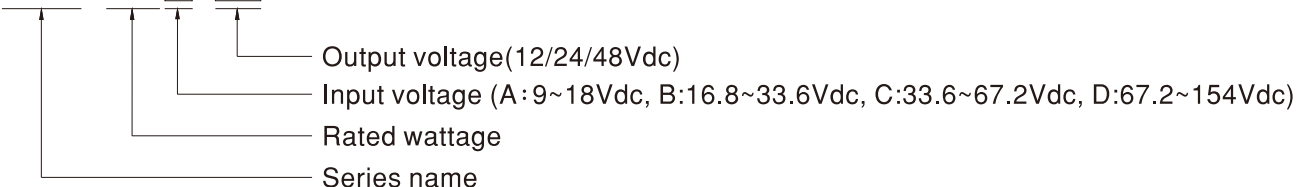



SPECIFICATION

| MODEL                 |  | DDR-120A-12   | DDR-120A-24                 | DDR-120A-48  | DDR-120B-12   | DDR-120B-24    | DDR-120B-48    |
|-----------------------|--|---|-----------------------------|--|---|----------------|----------------|
| OUTPUT                | DC VOLTAGE   | 12V   | 24V                         | 48V  | 12V   | 24V            | 48V            |
|                       | RATED CURRENT  | 8.3A  | 4.2A                        | 2.1A   | 10A   | 5A             | 2.5A           |
|                       | CURRENT RANGE  | 0 ~ 8.3A  | 0 ~ 4.2A                    | 0 ~ 2.1A   | 0 ~ 10A   | 0 ~ 5A         | 0 ~ 2.5A       |
|                       | RATED POWER  | 99.6W   | 100.8W                      | 100.8W   | 120W  | 120W           | 120W           |
|                       | PEAK CURRENT   | 12.45A  | 6.3A                        | 3.15A  | 15A   | 7.5A           | 3.75A          |
|                       | PEAK POWER <span style="float:right">Note.5</span>   | 150W (3sec.)  |                             |  | 180W (3sec.)  |                |                |
|                       | RIPPLE & NOISE (max.) <span style="float:right">Note.2</span>  | 50mVp-p   | 50mVp-p                     | 50mVp-p  | 50mVp-p   | 50mVp-p        | 50mVp-p        |
|                       | VOLTAGE ADJ. RANGE   | 9 ~ 14V   | 24 ~ 28V                    | 48 ~ 56V   | 9 ~ 14V   | 24 ~ 28V       | 48 ~ 56V       |
|                       | VOLTAGE TOLERANCE <span style="float:right">Note.3</span>  | ± 1.0%  | ± 1.0%                      | ± 1.0%   | ± 1.0%  | ± 1.0%         | ± 1.0%         |
|                       | LINE REGULATION  | ± 0.5%  | ± 0.5%                      | ± 0.5%   | ± 0.5%  | ± 0.5%         | ± 0.5%         |
|                       | LOAD REGULATION  | ± 1.0%  | ± 1.0%                      | ± 1.0%   | ± 1.0%  | ± 1.0%         | ± 1.0%         |
| SETUP, RISE TIME      | 500ms, 60ms @12Vdc   |   |                             | 500ms, 60ms @24Vdc   |   |                |                |
| HOLD UP TIME (Typ.)   | comply with 3ms@ full load   |   |                             | comply with S1 level (6ms) @ full load, S2 level (10ms) @ 70% load |   |                |                |
| INPUT                 | VOLTAGE RANGE <span style="float:right">Note.4</span>  | 9 ~ 18Vdc   | 9 ~ 18Vdc                   | 9 ~ 18Vdc  | 16.8 ~ 33.6Vdc  | 16.8 ~ 33.6Vdc | 16.8 ~ 33.6Vdc |
|                       | EFFICIENCY (Typ.)  | 88.5%   | 88.5%                       | 88.5%  | 89%   | 89.5%          | 91%            |
|                       | DC CURRENT (Typ.)  | 11.2A @12Vdc  |                             |  | 5.6A @24Vdc   |                |                |
|                       | INRUSH CURRENT (Typ.)  | 5A @12Vdc   |                             |  | 5A @ 24Vdc  |                |                |
| PROTECTION            | OVERLOAD   | Normally works within 150% rated output power for more than 3 seconds and then constant current protection 105~135% rated output power with auto-recovery |                             |  |   |                |                |
|                       | OVER VOLTAGE   | 14.4 ~ 16.8V  | 28.8 ~ 33.6V                | 57.6 ~ 67.2V   | 14.4 ~ 16.8V  | 28.8 ~ 33.6V   | 57.6 ~ 67.2V   |
|                       |  | Protection type : Shut down o/p voltage, re-power on to recover   |                             |  |   |                |                |
|                       | REVERSE POLARITY   | By internal MOSFET, no damage, recovers automatically after fault condition removed   |                             |  |   |                |                |
| UNDER VOLTAGE LOCKOUT | 12Vin (A - type) :Power ON ≥9V , OFF ≤8.5V   |   |                             | 24Vin (B - type) :Power ON ≥16.8V , OFF ≤16.5V                     |   |                |                |
| ENVIRONMENT           | WORKING TEMP.  | -40 ~ +70°C (Refer to "Derating Curve")   |                             |  |   |                |                |
|                       | WORKING HUMIDITY   | 5 ~ 95% RH non-condensing   |                             |  |   |                |                |
|                       | STORAGE TEMP., HUMIDITY  | -40 ~ +85°C, 5 ~ 95% RH non-condensing  |                             |  |   |                |                |
|                       | TEMP. COEFFICIENT  | ± 0.03%/°C (0 ~ 55°C)   |                             |  |   |                |                |
|                       | VIBRATION  | Component:10 ~ 500Hz, 5G 10min./1cycle, 60min. each along X, Y, Z axes; Mounting: Compliance to IEC61373  |                             |  |   |                |                |
| OPERATING ALTITUDE    | 2000 meters  |   |                             |  |   |                |                |
| SAFETY & EMC (Note 6) | SAFETY STANDARDS   | IEC 62368-1 (LVD), EAC TP TC 004, AS/NZS 62368.1 approved; Design refer to UL508  |                             |  |   |                |                |
|                       | WITHSTAND VOLTAGE  | I/P-O/P:4KVdc I/P-FG:2.5KVdc O/P-FG:2.5KVdc   |                             |  |   |                |                |
|                       | ISOLATION RESISTANCE   | I/P-O/P, I/P-FG, O/P-FG:>100M Ohms / 500Vdc / 25°C / 70% RH   |                             |  |   |                |                |
|                       | EMC EMISSION   | <b>Parameter</b>  | <b>Standard</b>             |  | <b>Test Level / Note</b>                                      |                |                |
|                       |  | Conducted   | EN55032                     |  | Class B   |                |                |
|                       |  | Radiated  | EN55032                     |  | Class B   |                |                |
|                       |  | Voltage Flicker   | EN61000-3-3                 |  | -----   |                |                |
|                       |  | Harmonic Current  | ----                        |  | -----   |                |                |
|                       | EMC IMMUNITY   | EN55024 , EN61000-6-2(EN50082-2)  |                             |  |   |                |                |
|                       |  | <b>Parameter</b>  | <b>Standard</b>             |  | <b>Test Level / Note</b>                                      |                |                |
|                       |  | ESD   | EN61000-4-2                 |  | Level 3, 8KV air ; Level 3, 6KV contact; criteria A           |                |                |
|                       |  | Radiated  | EN61000-4-3                 |  | Level 3, 10V/m ; criteria A                                   |                |                |
|                       |  | EFT / Burst   | EN61000-4-4                 |  | Level 3, 2KV ; criteria A                                     |                |                |
|                       |  | Surge   | EN61000-4-5                 |  | Level 3, 1KV/Line-Line ;Level 3, 2KV/Line-Line-FG ;criteria A |                |                |
| Conducted             |  | EN61000-4-6   |                             | Level 3, 10V ; criteria A  |   |                |                |
| Magnetic Field        | EN61000-4-8  |   | Level 4, 30A/m ; criteria A |  |   |                |                |
| RAILWAY STANDARD      | Compliance to EN45545-2 for fire protection ; Meet EN50155 / IEC60571 including IEC61373 for shock & vibration, EN50121-3-2 for EMC (except for 9~18Vin)   |   |                             |  |   |                |                |
| OTHERS                | MTBF   | 214.6K hrs min. MIL-HDBK-217F (25°C)  |                             |  |   |                |                |
|                       | DIMENSION  | 32*125.2*102mm (W*H*D)  |                             |  |   |                |                |
|                       | PACKING  | 510g; 28pcs/15.3Kg/1.22CUFT   |                             |  |   |                |                |
| NOTE                  | <p>1. All parameters NOT specially mentioned are measured at normal input (A:12Vdc , B:24Vdc) , rated load and 25°C of ambient temperature.</p> <p>2. Ripple &amp; noise are measured at 20MHz of bandwidth by using a 12" twisted pair-wire terminated with a 0.1 μ f &amp; 47 μ f parallel capacitor.</p> <p>3. Tolerance : includes set up tolerance, line regulation and load regulation.</p> <p>4. Derating may be needed under low input voltage. Please check the derating curve for more details.</p> <p>5. 3 seconds max., please refer to peak loading curves.</p> <p>6. The power supply is considered as an independent unit, but the final equipment still need to re-confirm that the whole system complies with the EMC directives. For guidance on how to perform these EMC tests, please refer to "EMI testing of component power supplies." (as available on <a href="http://www.meanwell.com">http://www.meanwell.com</a>)</p> <p>7. The ambient temperature derating of 3.5°C/1000m with fanless models and of 5°C/1000m with fan models for operating altitude higher than 2000m(6500ft).</p> |   |                             |  |   |                |                |



SPECIFICATION

| MODEL                 |   | DDR-120C-12   | DDR-120C-24                 | DDR-120C-48   | DDR-120D-12   | DDR-120D-24   | DDR-120D-48   |
|-----------------------|---|---|-----------------------------|---|---|---------------|---------------|
| OUTPUT                | DC VOLTAGE  | 12V   | 24V                         | 48V   | 12V   | 24V           | 48V           |
|                       | RATED CURRENT   | 10A   | 5A                          | 2.5A  | 10A   | 5A            | 2.5A          |
|                       | CURRENT RANGE   | 0 ~ 10A   | 0 ~ 5A                      | 0 ~ 2.5A  | 0 ~ 10A   | 0 ~ 5A        | 0 ~ 2.5A      |
|                       | RATED POWER   | 120W  | 120W                        | 120W  | 120W  | 120W          | 120W          |
|                       | PEAK CURRENT  | 15A   | 7.5A                        | 3.75A   | 15A   | 7.5A          | 3.75A         |
|                       | PEAK POWER <span style="float:right">Note.5</span>  | 180W (3sec.)  |                             |   |   |               |               |
|                       | RIPPLE & NOISE (max.) <span style="float:right">Note.2</span>   | 50mVp-p   | 50mVp-p                     | 50mVp-p   | 50mVp-p   | 50mVp-p       | 50mVp-p       |
|                       | VOLTAGE ADJ. RANGE  | 9 ~ 14V   | 24 ~ 28V                    | 48 ~ 56V  | 9 ~ 14V   | 24 ~ 28V      | 48 ~ 56V      |
|                       | VOLTAGE TOLERANCE <span style="float:right">Note.3</span>   | ± 1.0%  | ± 1.0%                      | ± 1.0%  | ± 1.0%  | ± 1.0%        | ± 1.0%        |
|                       | LINE REGULATION   | ± 0.5%  | ± 0.5%                      | ± 0.5%  | ± 0.5%  | ± 0.5%        | ± 0.5%        |
|                       | LOAD REGULATION   | ± 1.0%  | ± 1.0%                      | ± 1.0%  | ± 1.0%  | ± 1.0%        | ± 1.0%        |
| SETUP, RISE TIME      | 500ms, 60ms @48Vdc  |   |                             | 500ms, 60ms @110Vdc   |   |               |               |
| HOLD UP TIME (Typ.)   | comply with S1 level (6ms) @ full load, S2 level (10ms) @ 60% load  |   |                             | comply with S2 level (10ms) @ full load                       |   |               |               |
| INPUT                 | VOLTAGE RANGE <span style="float:right">Note.4</span>   | 33.6 ~ 67.2Vdc  | 33.6 ~ 67.2Vdc              | 33.6 ~ 67.2Vdc  | 67.2 ~ 154Vdc                                       | 67.2 ~ 154Vdc | 67.2 ~ 154Vdc |
|                       | EFFICIENCY (Typ.)   | 89.5%   | 91%                         | 92%   | 89.5%   | 91%           | 91.5%         |
|                       | DC CURRENT (Typ.)   | 2.8A @48Vdc   |                             |   | 1.3A @110Vdc  |               |               |
|                       | INRUSH CURRENT (Typ.)   | 5A @48Vdc   |                             |   | 5A @110Vdc  |               |               |
| PROTECTION            | OVERLOAD  | Normally works within 150% rated output power for more than 3 seconds and then constant current protection 105~135% rated output power with auto-recovery |                             |   |   |               |               |
|                       | OVER VOLTAGE  | 14.4 ~ 16.8V  | 28.8 ~ 33.6V                | 57.6 ~ 67.2V  | 14.4 ~ 16.8V  | 28.8 ~ 33.6V  | 57.6 ~ 67.2V  |
|                       |   | Protection type : Shut down o/p voltage, re-power on to recover   |                             |   |   |               |               |
|                       | REVERSE POLARITY  | By internal MOSFET, no damage, recovers automatically after fault condition removed   |                             |   |   |               |               |
| UNDER VOLTAGE LOCKOUT | 48Vin (C - type) :Power ON ≥ 33.6V , OFF ≤ 33V  |   |                             | 110Vin (D - type) :Power ON ≥ 67.2V , OFF ≤ 65V               |   |               |               |
| ENVIRONMENT           | WORKING TEMP.   | -40 ~ +70°C (Refer to "Derating Curve")   |                             |   |   |               |               |
|                       | WORKING HUMIDITY  | 5 ~ 95% RH non-condensing   |                             |   |   |               |               |
|                       | STORAGE TEMP., HUMIDITY   | -40 ~ +85°C, 5 ~ 95% RH non-condensing  |                             |   |   |               |               |
|                       | TEMP. COEFFICIENT   | ± 0.03%/°C (0 ~ 55°C)   |                             |   |   |               |               |
|                       | VIBRATION   | Component:10 ~ 500Hz, 5G 10min./1cycle, 60min, each along X, Y, Z axes; Mounting: Compliance to IEC61373  |                             |   |   |               |               |
| OPERATING ALTITUDE    | 2000 meters   |   |                             |   |   |               |               |
| SAFETY & EMC (Note 6) | SAFETY STANDARDS  | IEC 62368-1 (LVD), EAC TP TC 004, AS/NZS 62368.1 approved; Design refer to UL508  |                             |   |   |               |               |
|                       | WITHSTAND VOLTAGE   | I/P-O/P:4KVdc I/P-FG:2.5KVdc O/P-FG:2.5KVdc   |                             |   |   |               |               |
|                       | ISOLATION RESISTANCE  | I/P-O/P, I/P-FG, O/P-FG:>100M Ohms / 500Vdc / 25°C / 70% RH   |                             |   |   |               |               |
|                       | EMC EMISSION  | Parameter   | Standard                    |   | Test Level / Note                                   |               |               |
|                       |   | Conducted   | EN55032                     |   | Class B   |               |               |
|                       |   | Radiated  | EN55032                     |   | Class B   |               |               |
|                       |   | Voltage Flicker   | EN61000-3-3                 |   | -----   |               |               |
|                       | Harmonic Current  | -----   |                             | -----   |   |               |               |
|                       | EMC IMMUNITY  | EN55024 , EN61000-6-2(EN50082-2)  |                             |   |   |               |               |
|                       |   | Parameter   | Standard                    |   | Test Level / Note                                   |               |               |
|                       |   | ESD   | EN61000-4-2                 |   | Level 3, 8KV air ; Level 3, 6KV contact; criteria A |               |               |
|                       |   | Radiated  | EN61000-4-3                 |   | Level 3, 10V/m ; criteria A                         |               |               |
|                       |   | EFT / Burst   | EN61000-4-4                 |   | Level 3, 2KV ; criteria A                           |               |               |
| Surge                 |   | EN61000-4-5   |                             | Level 3, 1KV/Line-Line ;Level 3, 2KV/Line-Line-FG ;criteria A |   |               |               |
| Conducted             |   | EN61000-4-6   |                             | Level 3, 10V ; criteria A                                     |   |               |               |
| Magnetic Field        | EN61000-4-8   |   | Level 4, 30A/m ; criteria A |   |   |               |               |
| RAILWAY STANDARD      | Compliance to EN45545-2 for fire protection ; Meet EN50155 / IEC60571 including IEC61373 for shock & vibration, EN50121-3-2 for EMC   |   |                             |   |   |               |               |
| OTHERS                | MTBF  | 214.6K hrs min. MIL-HDBK-217F (25°C)  |                             |   |   |               |               |
|                       | DIMENSION   | 32*125.2*102mm (W*H*D)  |                             |   |   |               |               |
|                       | PACKING   | 510g; 28pcs/15.3Kg/1.22CUFT   |                             |   |   |               |               |
| NOTE                  | <p>1. All parameters NOT specially mentioned are measured at normal input (C:48Vdc , D:110Vdc) , rated load and 25°C of ambient temperature.</p> <p>2. Ripple &amp; noise are measured at 20MHz of bandwidth by using a 12" twisted pair-wire terminated with a 0.1 μf &amp; 47 μf parallel capacitor.</p> <p>3. Tolerance : includes set up tolerance, line regulation and load regulation.</p> <p>4. Derating may be needed under low input voltage. Please check the derating curve for more details.</p> <p>5. 3 seconds max., please refer to peak loading curves.</p> <p>6. The power supply is considered as an independent unit, but the final equipment still need to re-confirm that the whole system complies with the EMC directives. For guidance on how to perform these EMC tests, please refer to "EMI testing of component power supplies." (as available on <a href="http://www.meanwell.com">http://www.meanwell.com</a>)</p> <p>7. The ambient temperature derating of 3.5°C/1000m with fanless models and of 5°C/1000m with fan models for operating altitude higher than 2000m(6500ft).</p> |   |                             |   |   |               |               |

**Block Diagram**

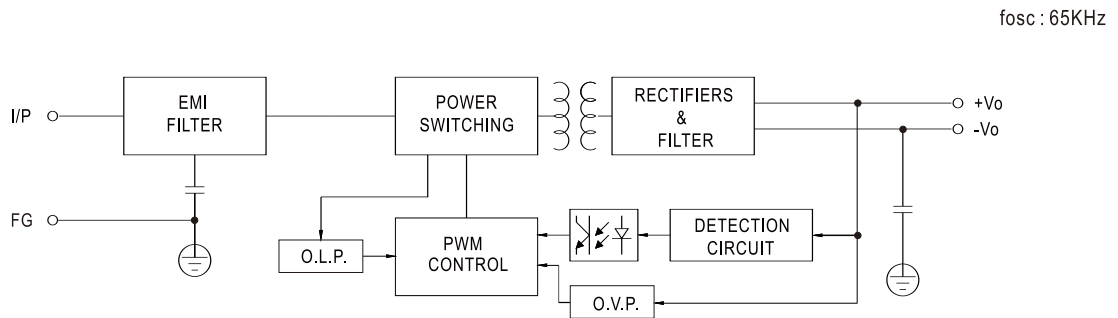

**Derating Curve**

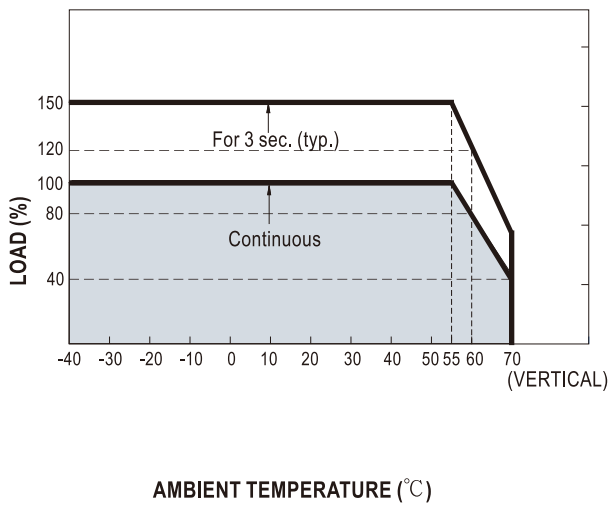

**Output derating VS input voltage**

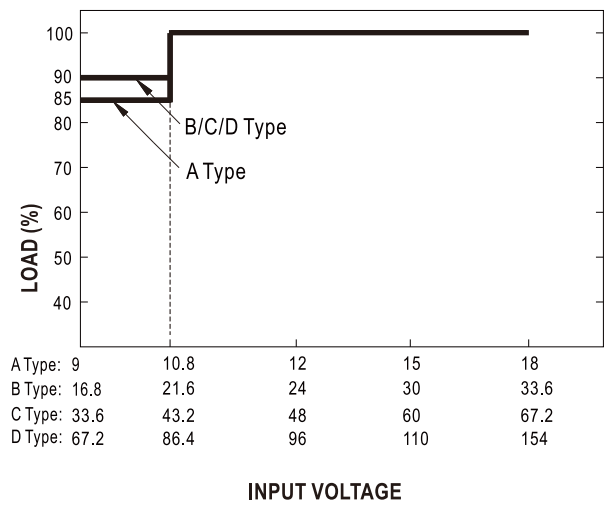

**Peak Loading**

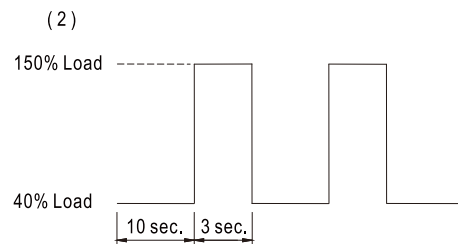
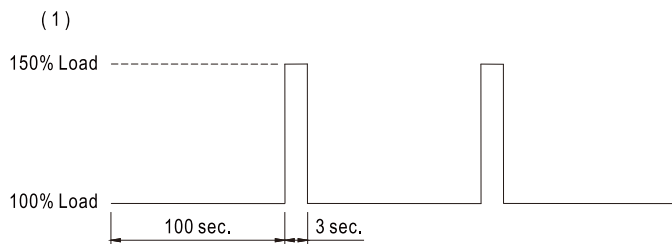

### Input Fuse

There is a fuse connected in series to the positive input line, which is used to protect against abnormal surge. Fuse specifications of each model are shown as below.

| Type | Fuse Type | Reference and Rating      |
|------|-----------|---------------------------|
| A    | Time-Lag  | Conquer MST, 10A, 250V *2 |
| B    | Time-Lag  | Conquer MST, 8A, 250V *2  |
| C    | Time-Lag  | Conquer MST, 8A, 250V *1  |
| D    | Time-Lag  | Conquer MST, 4A, 250V *1  |

### Input Under-Voltage Protection

If input voltage drops below  $V_{imin}$ , the internal control IC shuts down and there is no output voltage. It recovers automatically when input voltage reaches above  $V_{imin}$ , please refer to the curve below.

DDR-120A-24

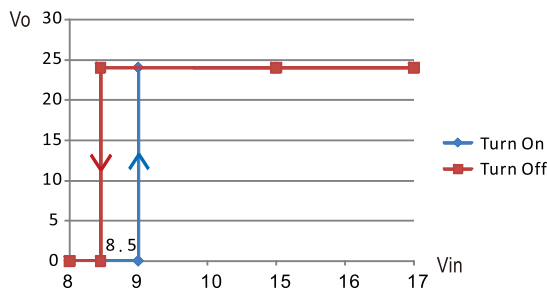

DDR-120B-24

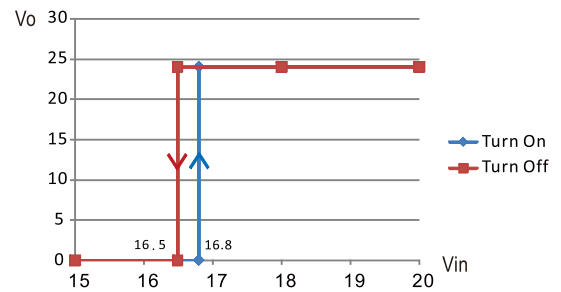

DDR-120C-24

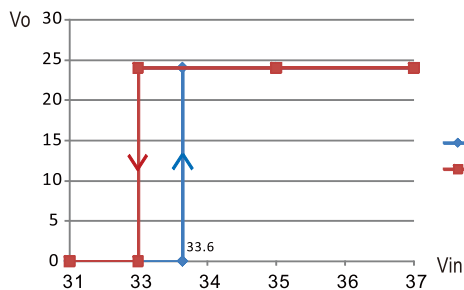

DDR-120D-24

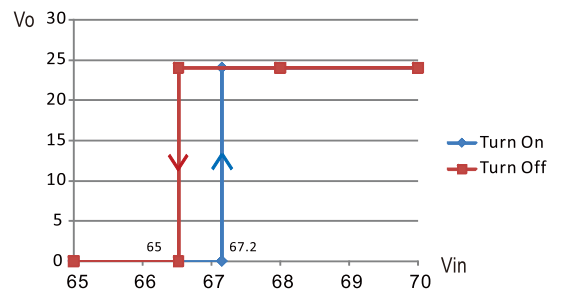

**■ Input Reverse Polarity Protection**

There is a MOSFET connected in series to the negative input line. If the input polarity is connected reversely, the MOSFET opens and there will be no output to protect the unit.

**■ Input Range and Transient Ability**

The series has a wide range input capability. With -30% / +40% of rated input voltage(except A Type), it can withstand that for 1 second.

**■ Inrush Current**

Inrush current is suppressed by a current limit circuit during the initial start-up, and then the circuit is bypassed by a MOSFET to reduce power consumption after accomplishing the start-up.

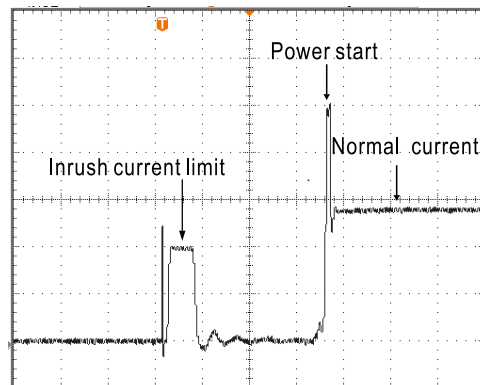

### Hold-up Time

D type is in compliance with S2 level (10ms), while A types are in compliance with S1 level (3ms) at full load output condition. To fulfil the requirements of S2 level (10ms), B types require de-rating their output load to 70%, C types require de-rating their output load to 60%, please refer to the curve diagrams below.

DDR-120A-12

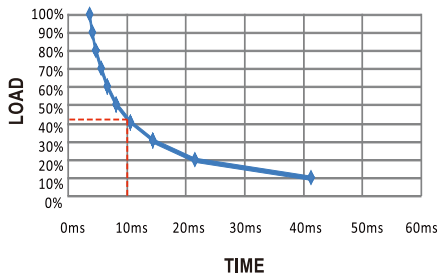

DDR-120A-24

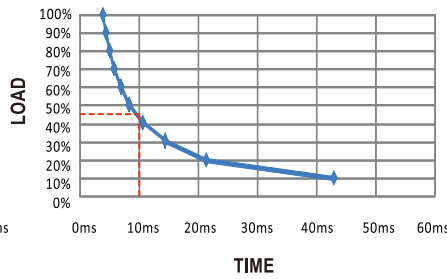

DDR-120A-48

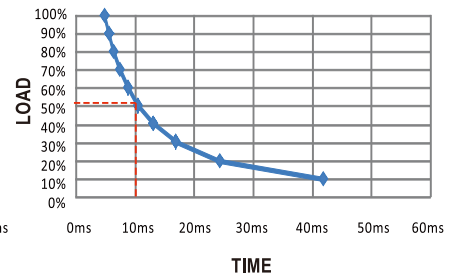

DDR-120B-12

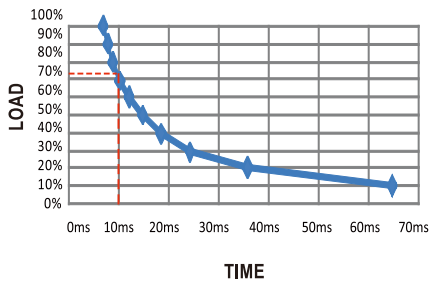

DDR-120B-24

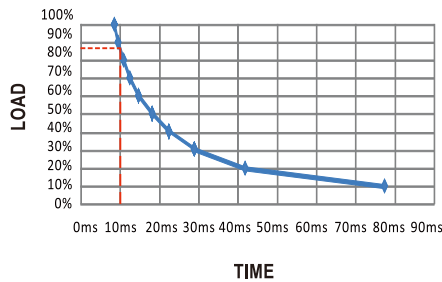

DDR-120B-48

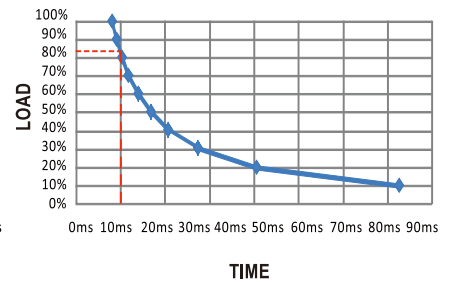

DDR-120C-12

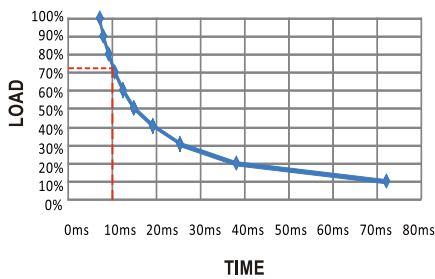

DDR-120C-24

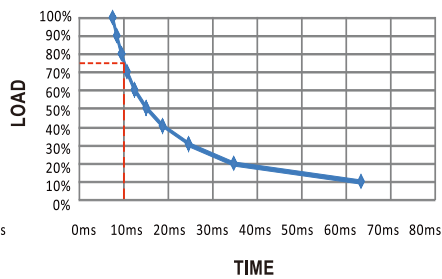

DDR-120C-48

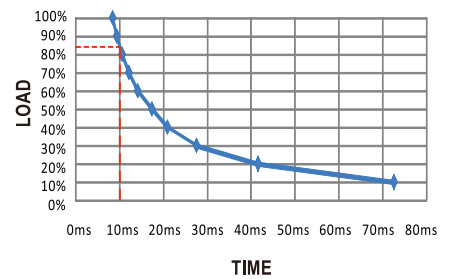

DDR-120D-12

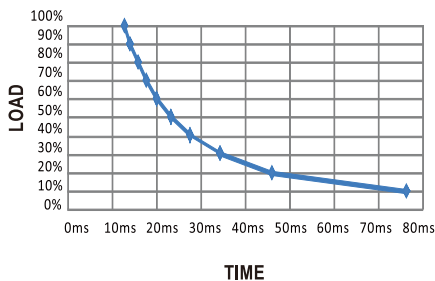

DDR-120D-24

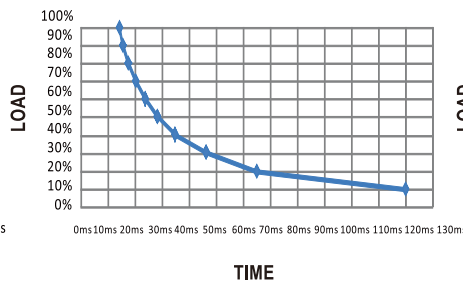

DDR-120D-48

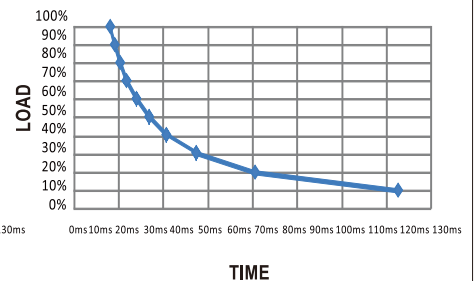

## Efficiency vs Load & Vin Curve

The efficiency vs load & Vin curves of each model are shown as below.

DDR-120A-12

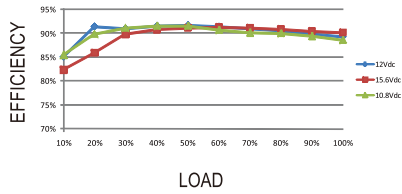

DDR-120A-24

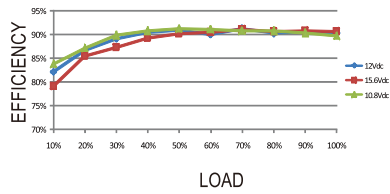

DDR-12A-48

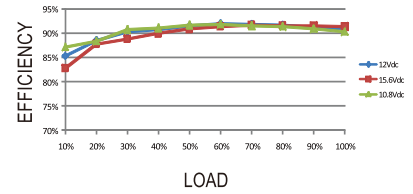

DDR-120B-12

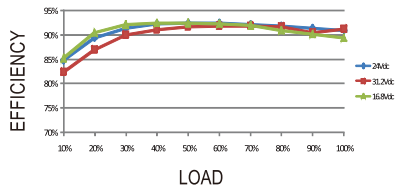

DDR-120B-24

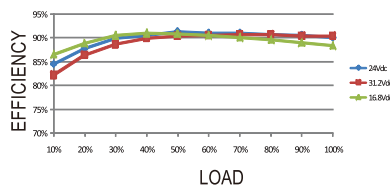

DDR-120B-48

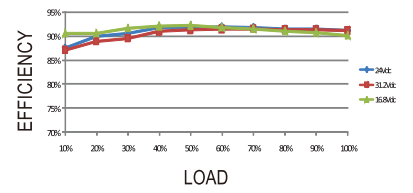

DDR-120C-12

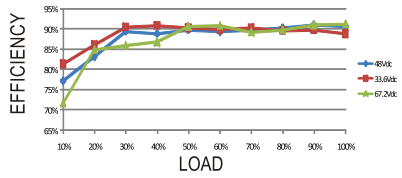

DDR-120C-24

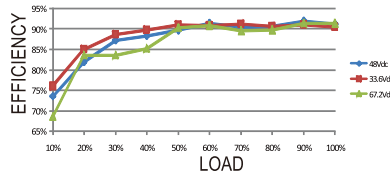

DDR-120C-48

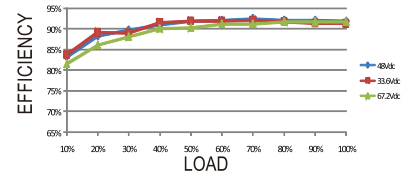

DDR-120D-12

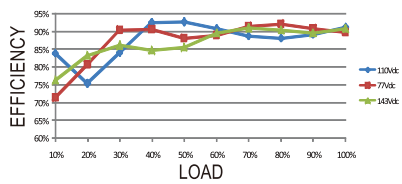

DDR-120D-24

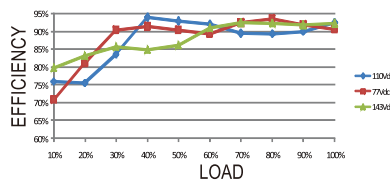

DDR-120D-48

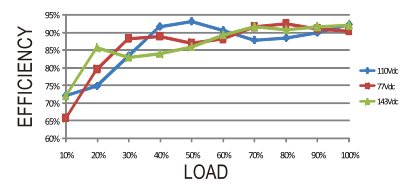





**Immunity to Environmental Conditions**

| Test method                  | Standard  | Test conditions   | Status    |
|------------------------------|---|---|-----------|
| Cooling Test                 | EN 50155 section 12.2.3 (Column 2, Class TX)<br>EN 60068-2-1  | Temperature: -40°C<br>Dwell Time: 2 hrs/cycle                       | No damage |
| Dry Heat Test                | EN 50155 section 12.2.4 (Column 2, Class TX)<br>EN 50155 section 12.2.4 (Column 3, Class TX & Column 4, Class TX)<br>EN 60068-2-2 | Temperature: 70°C / 85°C<br>Duration: 6 hrs / 10min                 | PASS      |
| Damp Heat Test, Cyclic       | EN 50155 section 12.2.5<br>EN 60068-2-30  | Temperature: 25°C~55°C<br>Humidity: 90%~100% RH<br>Duration: 48 hrs | PASS      |
| Vibration Test               | EN 50155 section 12.2.11<br>EN 61373  | Temperature: 19°C<br>Humidity: 65%<br>Duration: 10 mins             | PASS      |
| Increased Vibration Test     | EN 50155 section 12.2.11<br>EN 61373  | Temperature: 19°C<br>Humidity: 65%<br>Duration: 5 hrs               | PASS      |
| Shock Test                   | EN 50155 section 12.2.11<br>EN 61373  | Temperature: 21 ± 3°C<br>Humidity: 65 ± 5%<br>Duration: 30ms*18     | PASS      |
| Low Temperature Storage Test | EN 50155 section 12.2.3 (Column 2, Class TX)<br>EN 60068-2-1  | Temperature: -40°C<br>Dwell Time: 16 hrs                            | PASS      |
| Salt Mist Test               | EN 50155 section 12.2.10 (Class ST4)  | Temperature: 35°C ± 2°C<br>Duration: 96 hrs                         | PASS      |

**EN45545-2 Fire Test Conditions**

| Test Items |                     |                                       | Hazard Level |      |      |
|------------|---------------------|---------------------------------------|--------------|------|------|
|            | Items               | Standard                              | HL1          | HL2  | HL3  |
| R22        | Oxygen index test   | EN 45545-2:2013<br>EN ISO 4589-2:1996 | PASS         | PASS | PASS |
|            | Smoke density test  | EN 45545-2:2013<br>EN ISO 5659-2:2006 | PASS         | PASS | PASS |
|            | Smoke toxicity test | EN 45545-2:2013<br>NF X70-100:2006    | PASS         | PASS | PASS |
| R24        | Oxygen index test   | EN 45545-2:2013<br>EN ISO 4589-2:1996 | PASS         | PASS | PASS |
| R25        | Glow-wire test      | EN 45545-2:2013<br>EN 60695-2-11:2000 | PASS         | PASS | PASS |
| R26        | Vertical flame test | EN 45545-2:2013<br>EN 60695-11:2003   | PASS         | PASS | PASS |

**Mechanical Specification**

Case No. Unit:mm

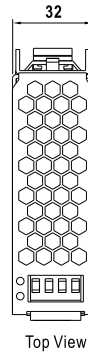

Terminal Pin No. Assignment (TB2)

| Pin No. | Assignment    |
|---------|---------------|
| 1,2     | DC Output -Vo |
| 3,4     | DC Output +Vo |

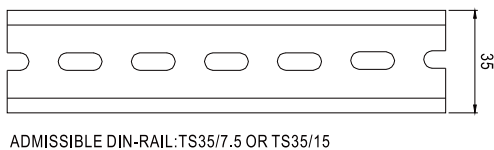
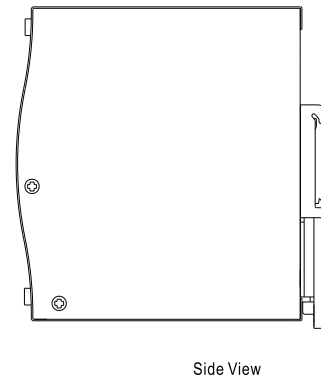
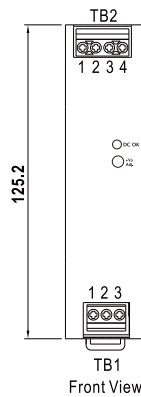
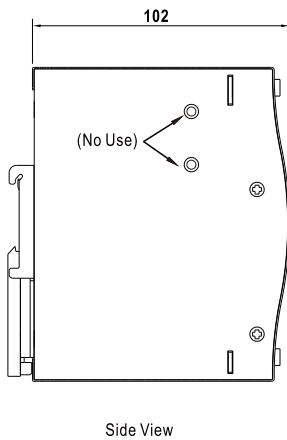

Terminal Pin No. Assignment (TB1)

| Pin No. | Assignment    |
|---------|---------------|
| 1       | FG ⊕          |
| 2       | DC Input -Vin |
| 3       | DC Input +Vin |

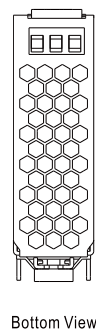

**Installation Manual**

Please refer to : <http://www.meanwell.com/manual.html>